



Shipping Rates Calculator

Table of Contents

Version History	4
Getting Started: The Rate Calculator	4
Using Rate Service Calculator: How Does it Work?	5
1. Xml Structure Diagrams:	6
2. Data Type Element Description.....	14
2.1 Client Info	14
2.2 Transaction	15
2.3 Address	15
2.4 Shipment Details.....	16
2.5 Date Time.....	18
2.6 Shipment Items	18
2.7 Attachment	19
2.8 Label Info	19
2.9 Dimensions	19
2.10 Weight	20
2.11 Money.....	20
2.12 Volume	21
3. RESPONSE.....	21
3.1 Transaction	21
3.2 Has Errors.....	21
3.3 List of Notifications.....	22
3.4 Total amount.....	22
4. Rate Calculator conditions:	22
5. Images of the Back-end User Interface.....	23

4.1 A Valid Request with Account Information	23
4.2 A Valid Request without Account Information	24
APPENDIX: Aramex and General References	25
Appendix A - Product Types	26
Appendix B - Shipment Payment Methods	26
Appendix C - Service Codes	27
Appendix D - ISO Country Codes	27
Appendix E - Currency Codes	31
Appendix F - Error Codes and Messages	39

List of Tables

Table 1: Rate Calculator Request Diagram and Description	7
Table 2: Client Info Child Element Diagram	8
Table 3: Transaction, Origin and Destination Address Child Element Diagram	9
Table 4: Shipment Details Child Element Diagram.....	11
Table 4.1: Elaboration on Complex Elements	12
Table 5: Shows the list of Elements present in the Client Info Structure	13
Table 6: Shows the list of Elements present in the Transaction Structure	14
Table 17: List of Elements present in the Address Structure	14
Table 19: list of Elements present in the Shipment Details Structure	15
Table 20: list of Elements present in the Date Time Structure	17
Table 21: list of Elements present in the Shipment Item Structure	17
Table 22: list of Elements present in the Attachment Structure	17
Table 23: list of Elements present in the Label Info Structure	18
Table 24: list of Elements present in the Dimensions Structure	18
Table 25: list of Elements present in the Weight Structure	19
Table 26: list of Elements present in the Money Structure	19
Table 27: list of Elements present in the Volume Structure	19
Table 10: Transaction Response Description	20
Table 11: Reply - List of Notifications	20
Table 12: Reply-Total Amount (Calculated Rate)	21

Version History		
Version	Change	Effective Date
1	Document Creation	June 2011
2	New Sections <ul style="list-style-type: none">- Rate Calculator conditions (page 20)	1st of January 2013

Getting Started: The Rate Calculator

The Aramex Shipping APIs (Application Programming Interface) allows your system to communicate directly with our shipping and tracking system over the internet. Our API provides you with wide varieties of functionalities which enable customers to integrate with Aramex's system from their own systems in an automated way. The API provides a secure channel and can be called through

encrypted HTTPS channel. This Document contains a complete guide on how to use the Rate Calculator API, which is one of the main functionalities required by customers to start shipping. The Rate Calculator determines how much the customer will get charged for the delivery from the source of the product to the final destination. The Rate Calculator API also provides these features:

- The validation of User name and Password given by the client for a more secure access, while ensuring that your customer's privacy is not violated.
- A wider range of options for customers to provide full details about their shipments, enabling Aramex to calculate rates more accurately.
- Validation of address allows the service to prompt the customer for more information in case of inaccuracy or empty fields with our Address Validation Service.
- Provides asynchronous transmission, in case the customer would like to send and receive data asynchronously. In this case, customers need to provide a transaction ID of his own choice in the request which will be passed back in the reply.
- Simple processes in which a customer can fill basic information related to shipments and system will provide the rate.

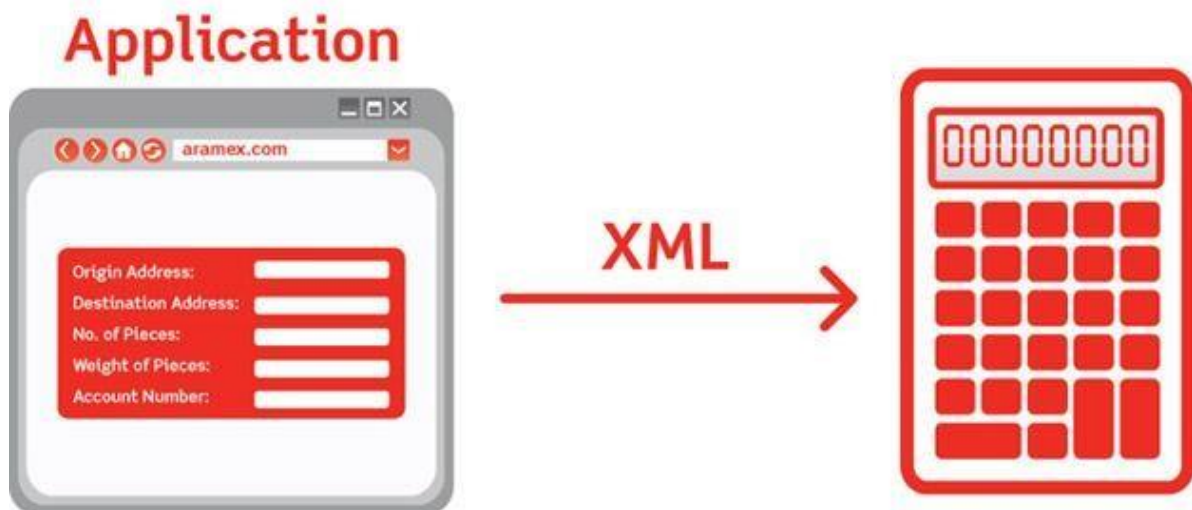

Using Rate Service Calculator: How does it work?

- The Rates Calculator uses a Web Service Definition Language (WSDL) will is provided by Aramex, enabling developers to add reference to the web service in their code. A WSDL file will be available on aramex.com or can be provided by the Aramex Electronic Data Interchange (EDI) team. [Please contact us for the WSDL](#) files.
- Once the developer adds the reference to the web service he will be able to build the request message, through the Rate Request XML, and invoke the service and get a reply message with the rates.
- The user must be registered at Aramex with a valid user name and password.
- Sample Codes will be available in both VB and C# and PHP on aramex.com.

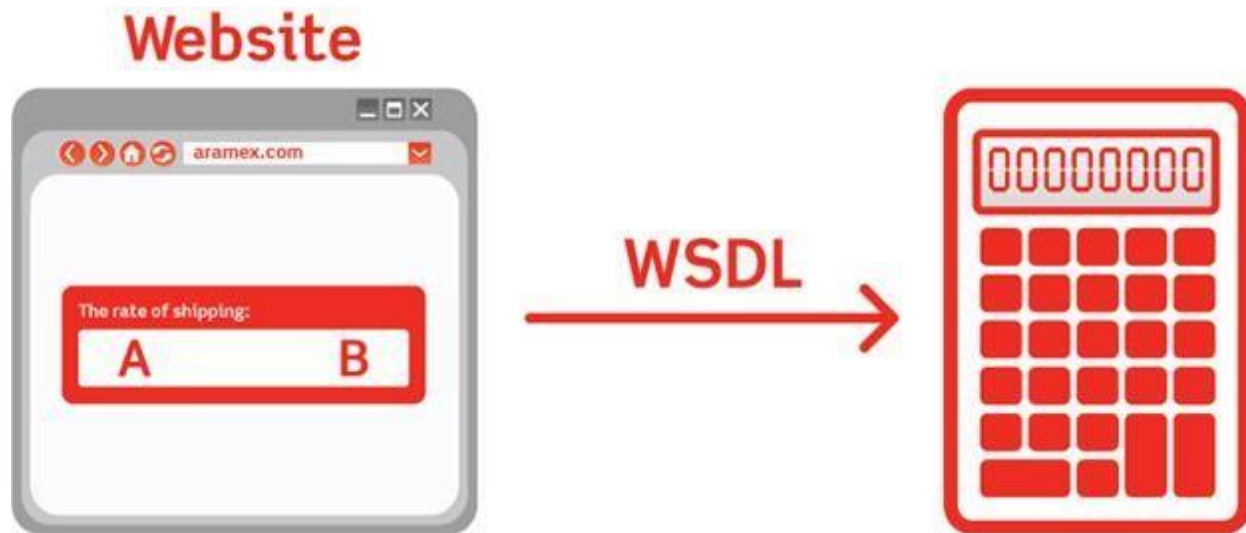

1.Xml Structure Diagrams:

XML request or reply messages have to be constructed as explained below. The Tables below show the structure, element, child element, semantics as well as the validation conditions in a Rate Request XML.

Table 1: Rate Calculator Request Diagram and Description

Diagram	Description
<p>Fig.1. Rate Calculator Structure Request</p>	<p>Element: Client Info Purpose: - For client Validation purposes.</p> <p>Element: Transaction Purpose: For the customer to send any type of data such as identification data which will be sent back in the Reply, easier to track requests and transactions.</p> <p>Element: Origin Address Purpose: To identify the desired physical shipment origin location details and validates them to be a factor in rate calculation.</p> <p>Element: Destination Address Purpose: To identify the desired shipment Destination location details and validates them to be a factor in rate calculation.</p> <p>Element: Shipment Details Purpose: Several aspects about the shipment some required to be filled, other aspects are optional if the customer wished to include extra features.</p>

Table 2: Client Info Child Element Diagram

Diagram	Description
---------	-------------

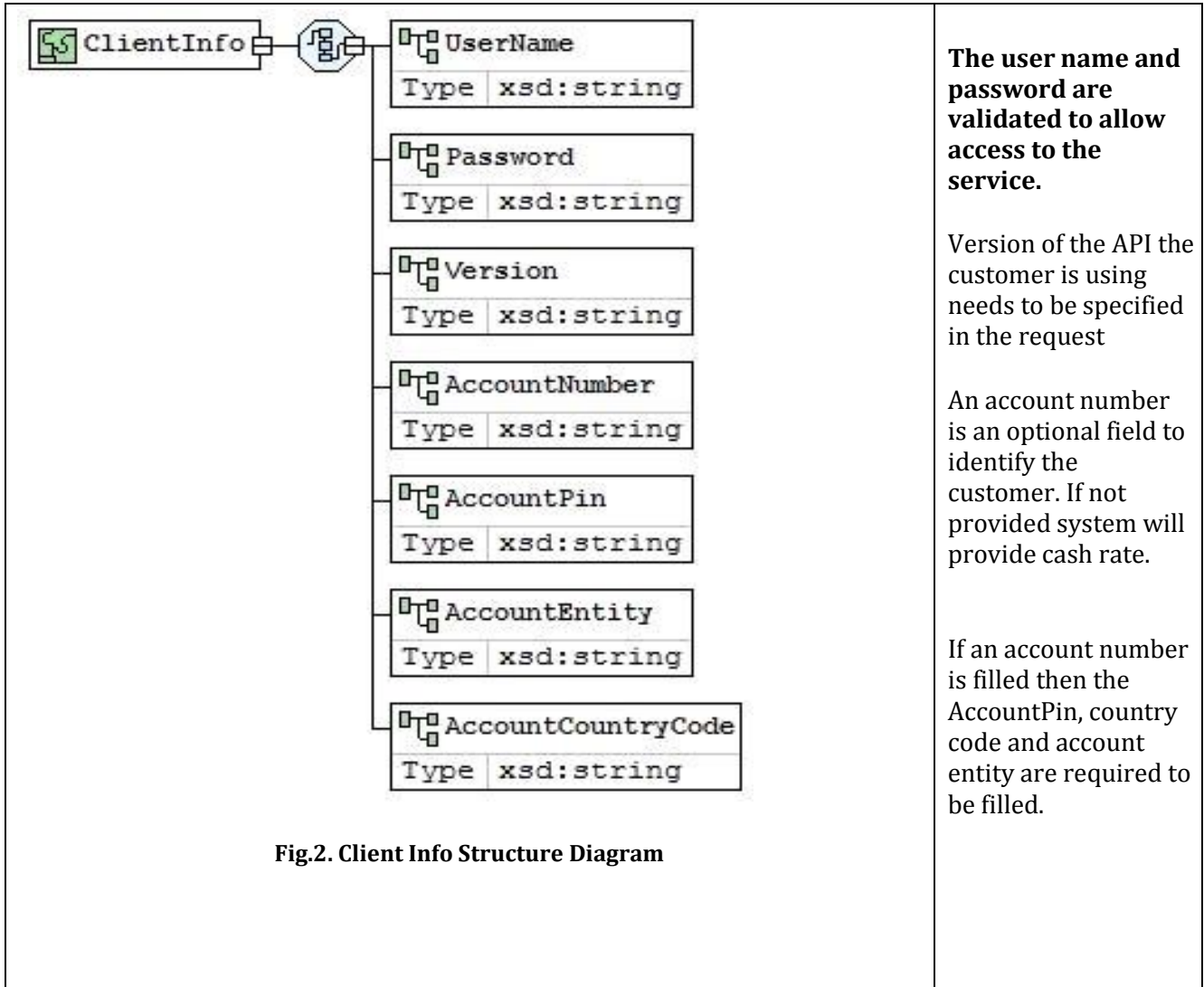

The user name and password are validated to allow access to the service.

Version of the API the customer is using needs to be specified in the request

An account number is an optional field to identify the customer. If not provided system will provide cash rate.

If an account number is filled then the AccountPin, country code and account entity are required to be filled.

Table 3: Transaction, Origin and Destination Address Child Element Diagram

Diagram	Description
---------	-------------

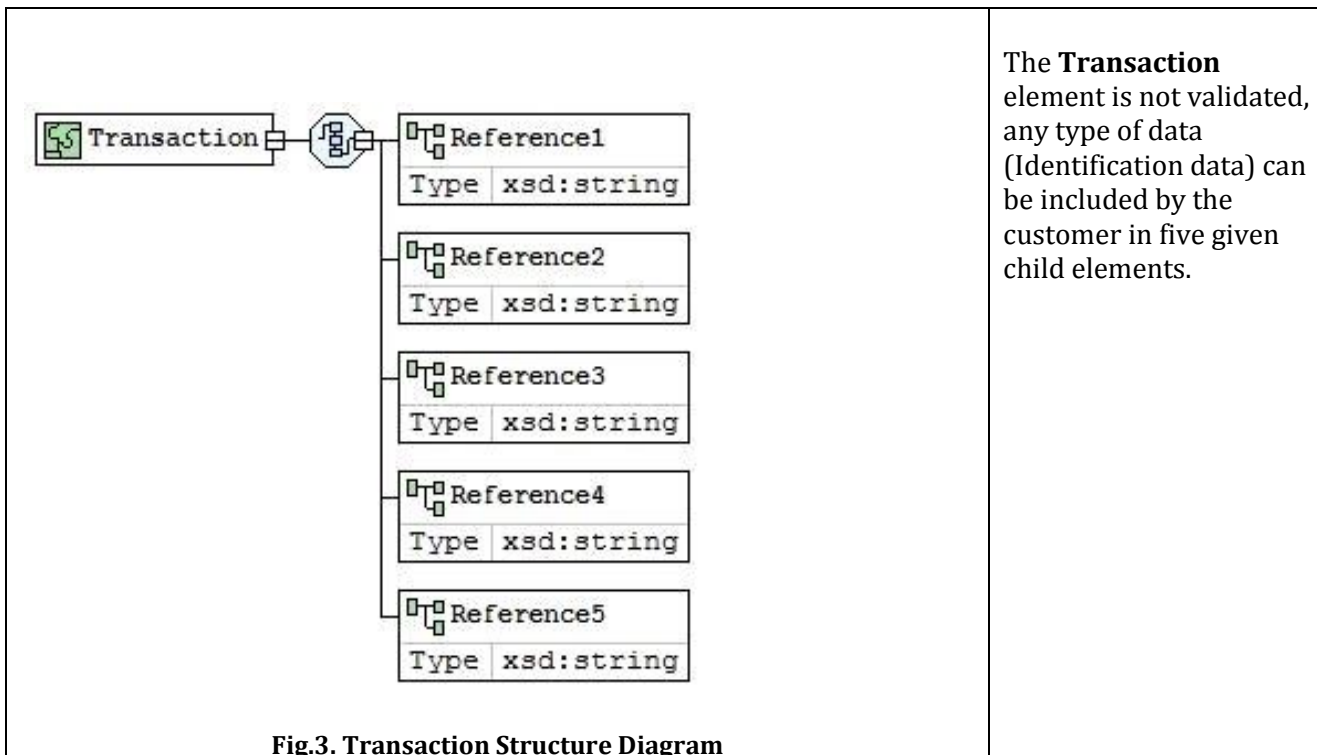

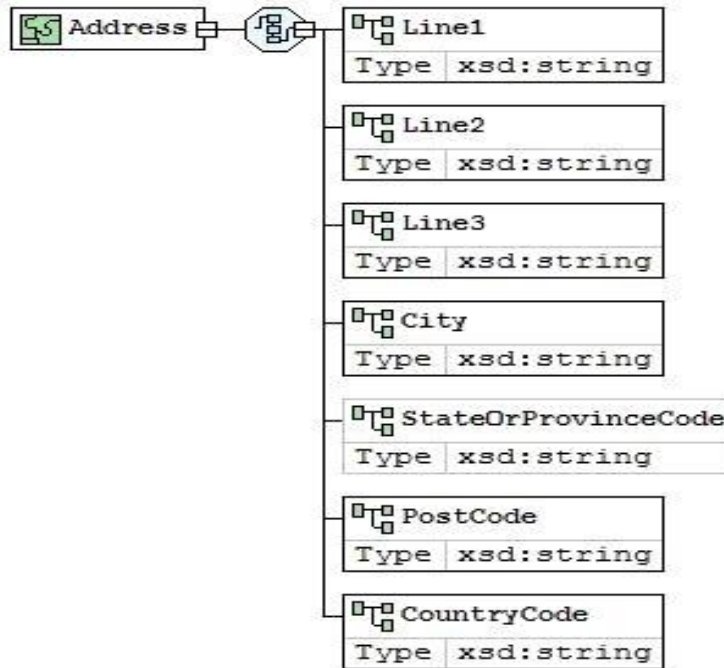

Fig.4. Transaction Structure Diagram

The **Address** Elements represent the same diagram for the Origin and Destination addresses.

Both are validated according to the Product group.

Domestic Product group (DOM) only accepts the same Country Code for Origin and Destination, as well as a valid city for this country.

International Product group (EXP) only accepts a different Country Code with valid Cities.

The Post Code, State or Province Code fields are required for countries that support them.

Table 4: Shipment Details Child Element Diagram

Diagram	Description
---------	-------------

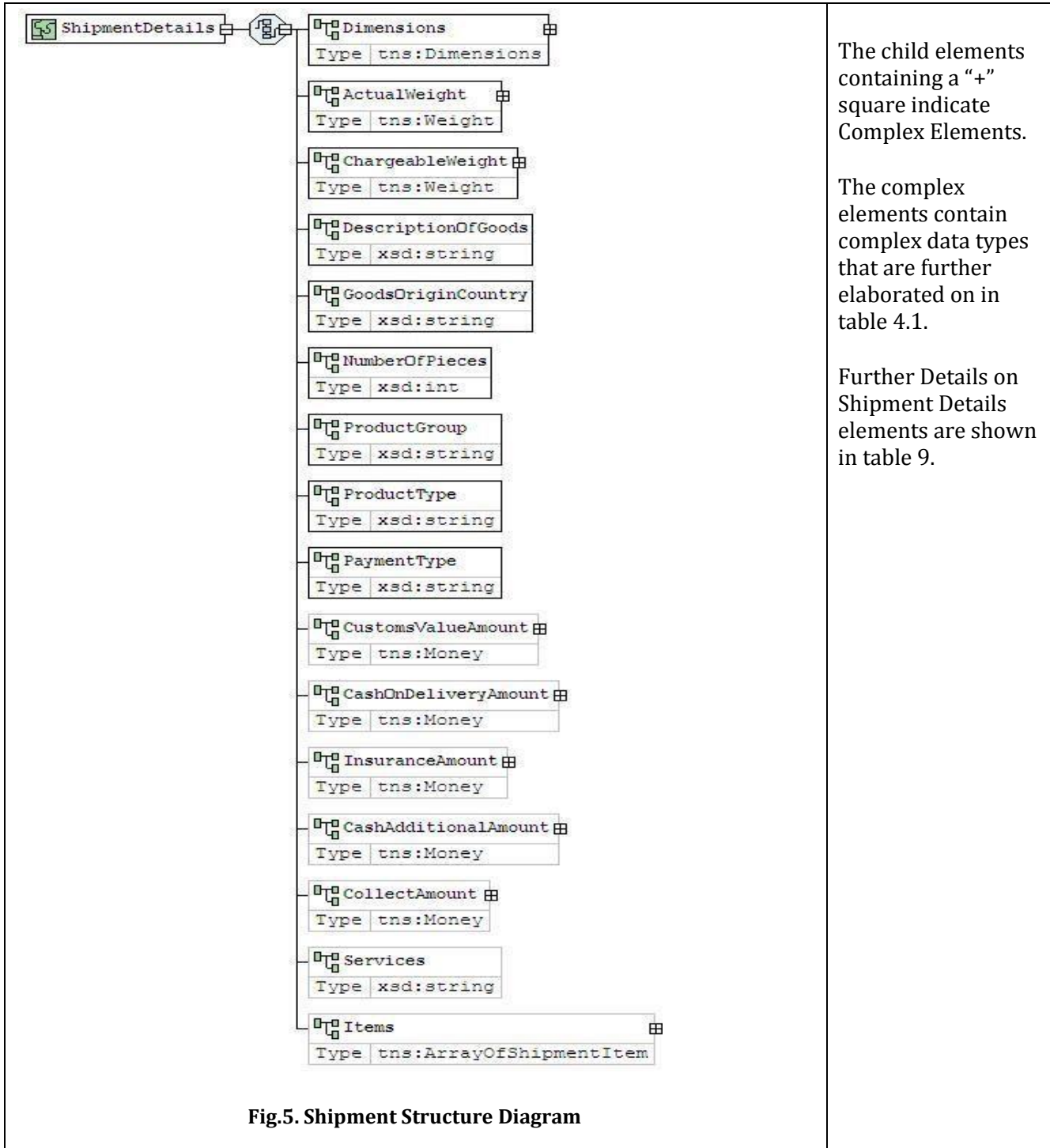

The child elements containing a “+” square indicate Complex Elements.

The complex elements contain complex data types that are further elaborated on in table 4.1.

Further Details on Shipment Details elements are shown in table 9.

Fig.5. Shipment Structure Diagram

Table 4.1: Elaboration on Complex Elements

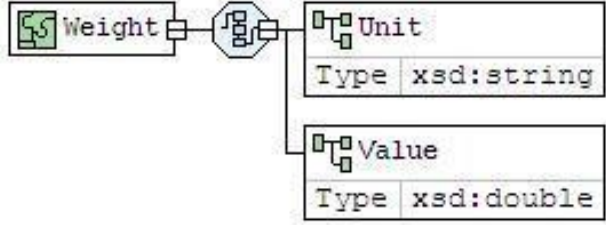
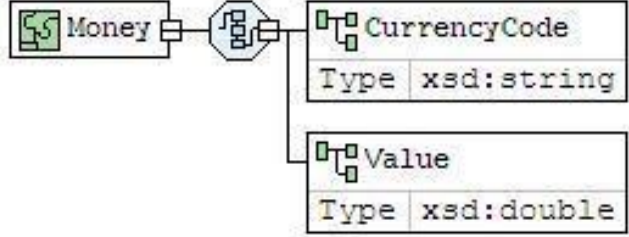
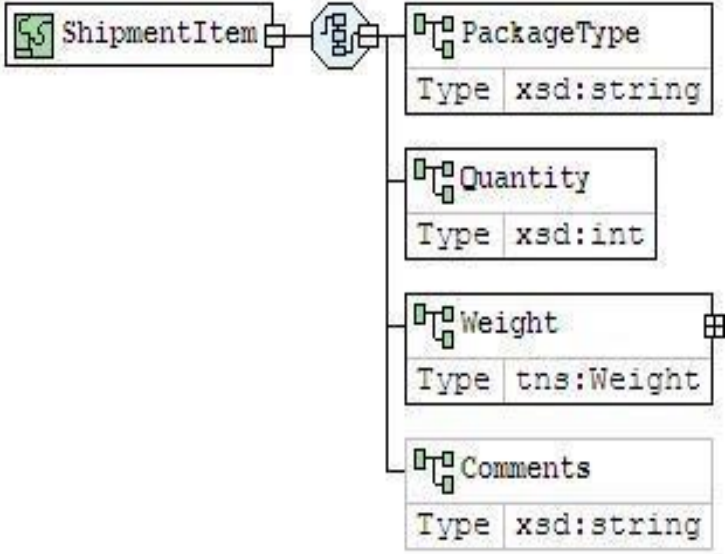
Diagram	Description
 <p data-bbox="462 747 818 779">Fig.6. Weight Structure Diagram</p>	<p data-bbox="1141 474 1466 709">Weight is a complex element, consisting of two child elements, Unit and Value, which apply to every element that is defined by the Data Type "Weight".</p>
 <p data-bbox="462 1146 818 1178">Fig.7. Money Structure Diagram</p>	<p data-bbox="1141 861 1466 1096">Money is a complex element, consisting of two child elements, Currency Code and Value, which apply to every element that is defined by the Data Type "Money".</p>
 <p data-bbox="420 1860 857 1892">Fig.8. Shipment Item Structure Diagram</p>	<p data-bbox="1141 1260 1466 1562">ShipmentItem is a complex element consisting of four child elements. Every Shipment can consist of several items and each item has the following: PackageType, Quantity, Weight, Comments</p>

2. Data Type Element Description

Further details on child elements of the Rate Service Calculator and their attributes can be shown below.

Element: Element Name

Data Type: The type of data that can be inserted into this field.

Required: Specifies three categories

- **M** = Mandatory, This field must be filled in all cases.
- **O** = Optional, This field may or may not be filled.
- **C** = Conditional, This field may or may not be filled depending on another field being filled.

Length: The maximum number of characters allowed in this field.

Allowed Values: Specifies the accepted data by this field.

2.1 Client Info

Table 5: Shows the list of Elements present in the Client Info Structure

Element	Data Type	Required	Length	Allowed Values	Description
User Name	Alphanumeric	M	50		A unique user name sent to the customer upon registration with http://www.aramex.com
Password	Alphanumeric	M	50		A unique password to verify the user name, sent to the client upon registration with http://www.aramex.com
Version	Alphanumeric	M	4	V1.0	Based on the WSDL the customer is using to invoke the web service
Account Entity	Character	C	3		Identification Code/Number for Transmitting Party. This code should be provided to you by Aramex.
Account Number	Alphanumeric	O	50		The Customer's Account number provided by Aramex when the contract is signed.

Account PIN	Alphanumeric	C	50		A key that is given to account customers associated with the account number, so as to validate customer identity.
Account Country Code	Character	C	2		Two Letter Code Identifying the Country. Refer to Appendix D

2.2 Transaction

Table 6: Shows the list of Elements present in the Transaction Structure

Element	Data Type	Required	Length	Allowed Values	Description
Reference 1	Alphanumeric	0	50		Any Details the Customer would like to add to be able to identify the transaction in the future.
Reference 2	Alphanumeric	0	50		Any Details the Customer would like to add to be able to identify the transaction in the future.
Reference 3	Alphanumeric	0	50		Any Details the Customer would like to add to be able to identify the transaction in the future.
Reference 4	Alphanumeric	0	50		Any Details the Customer would like to add to be able to identify the transaction in the future.
Reference 5	Alphanumeric	0	50		Any Details the Customer would like to add to be able to identify the transaction in the future.

2.3 Address

Table 17: List of Elements present in the Address Structure

Element	Data Type	Required	Length	Allowed Values	Description
Line1	String	M	50	More than 3 characters	Additional Address information, such as the building number, block, street name.
Line2	String	0	50		Additional Address information.
Line3	String	0	50		Additional Address information.

City	String	C	50		Address City. Conditional: Required if the post code is not given.
State Or Province Code	String	C	100		Address State or province code. Required if The country code and city require a State or Province Code
Post Code	String	C	30		Postal Code, if there is a postal code in the country code and city then it must be given.
Country Code	String	M	2		2-Letter Standard ISO Country Code. Refer to Appendix D for a complete list of Country codes.

2.4 Shipment Details

Table 19: list of Elements present in the Shipment Details Structure

Element	Data Type	Required	Length	Allowed Values	Description
Dimensions	Dimensions	O			Measurements required in calculating the Chargeable Weight, If any of the dimensional values are filled then the rest must be filled.
NumberOfPieces	Integer	M	3	Pieces > 0 MAX = 100	Number of shipment pieces
ActualWeight	Weight	M	6		Total actual shipment weight. If the Dimensions are filled, charging weight is compared to actual and the highest value is filled here.
Product Group	String	M	3	EXP, DOM	EXP = Express DOM = Domestic
Product Type	String	M	3	Product Type: "OND" For Product Group: "DOM"	Product Type involves the specification of certain features concerning the delivery of the product such as: Priority, Time Sensitivity, and whether it is a Document or Non-Document. Refer to Appendix A for a list of Product Types and their Product Groups

Your Guide to Embedding Aramex's Rate Calculator

Payment Type	String	M	1	P, C, 3	Method of payment for shipment. Refer to Appendix B for more details.
Payment Options	String	C	4	Payment Type = C ASCC ARCC Payment Type = P CASH ACCT PPST CRDT	Conditional - Based on the Payment Type "C" ASCC = Needs Shipper Account Number to be filled. ARCC = Needs Consignee Account Number to be filled. Optional - Based on the Payment Type "P" then it is optional to fill. CASH = Cash ACCT = Account PPST = Prepaid Stock

					CRDT = Credit
Services	String	O	25		Additional services used in shipping the package, separate by comma when selecting multiple services. Refer to Appendix C (Service Codes) for valid codes.
Description of Goods	String	M	100		The nature of shipment contents. Example: Clothes, Electronic Gadgets
Goods Origin Country	String	M	2		The origin of which the product in the shipment came from. Refer to Appendix D for a complete list of Country codes.
Customs Value amount	Money	C			Value charged by destination customs. Conditional - Based on the ProductType "Dutible"
Cash on Delivery	Money	C			Amount of Cash that is paid by the receiver of the package. Conditional - Based on the Services "COD" being filled.

Insurance Amount	Money	O			Insurance amount charged on shipment.
Cash Additional Amount	Money	O			Additional Cash that can be required for miscellaneous purposes.
Cash Additional Description	String	C			Conditional - Based on the PaymentType "3" AND Cash Additional Amount is filled
Collect Amount	Money	C			Transportation Charges to be collected from consignee. Conditional - Based on the PaymentType "C" + PaymentOptions "ARCC"
Items	<u>List(Of ShipmentItem)</u>	O			Details of the Items within a shipment. Several items can be added for a single shipment.

2.5 Date Time

Table 20: list of Elements present in the Date Time Structure

Element	Data Type	Required	Length	Allowed Values	Description
Shipping Date	Date	M			The date Aramex receives the shipment to be shipped out.
Due Date	Date	M			The date specified for shipment to be delivered to the consignee.

2.6 Shipment Items

Table 21: list of Elements present in the Shipment Item Structure

Element	Data Type	Required	Length	Allowed Values	Description
Package Type	String	C	50		Type of packaging, for example. Cans, bottles, degradable Plastic. Conditional: If any of the Item element values are filled then the rest must be filled.
Weight	Weight	C			Total Weight of the Items
Quantity	Integer	C	4	MAX = 100	Number of items

Comments	String	C	1000		Additional Comments or Information about the items
----------	--------	---	------	--	--

2.7 Attachment

Table 22: list of Elements present in the Attachment Structure

Element	Data Type	Required	Length	Allowed Values	Description
File Name	String	C			The file name without its extension.
File Extension	String	C	6		The extension of the file. Our system accepts any extension
File Contents	Byte()	C	4 MB		Contents of the file.

2.8 Label Info

Table 23: list of Elements present in the Label Info Structure

Element	Data Type	Required	Length	Allowed Values	Description
Report ID	Integer	M		9201	The Template of the report to be generated.
Report Type	String	M		"URL" or "RPT"	Either by URL or a streamed file (RPT). URL by Default

2.9 Dimensions

Table 24: list of Elements present in the Dimensions Structure

Element	Data Type	Required	Length	Allowed Values	Description
Length	Double	C	5	Format: 000.000 MAX = 100	Measurements required in calculating the Chargeable Weight, If any of the Dimensional values are filled then the rest must be filled.
Width	Double	C	5	Format: 000.000 MAX = 100	Measurements required in calculating the Chargeable Weight, If any of the Dimensional values are filled then the rest must be filled.

Height	Double	C	5	Format: 000.000 MAX = 100	Measurements required in calculating the Chargeable Weight, If any of the Dimensional values are filled then the rest must be filled
Unit	String	C	2	CM, M	Measurement Unit, If any of the Dimensional values are filled then the rest must be filled. CM = Centimeter M = Meter

2.10 Weight

Table 25: list of Elements present in the Weight Structure

Element	Data Type	Required	Length	Allowed Values	Description
Value	Double	M	6	Format: 000.000 Weight > 0 MAX = 100	Shipment weight. If the Data Entity 'Dimensions' are filled, charging weight is compared to actual and the highest value is filled here.
Unit	String	0	2	KG , LB	Unit of the weight

2.11 Money

Table 26: list of Elements present in the Money Structure

Element	Data Type	Required	Length	Allowed Values	Description
Currency Code	String	C	3		3-Letter Standard ISO Currency Code Refer to Appendix E for a list of Currency Codes. If Cash on delivery value is filled, then its currency must be in USD.
Value	Double	C	5	Format: 000.000 MAX = 100	The Monetary value. For Cash on delivery , the currency must be in USD.

2.12 Volume

Table 27: list of Elements present in the Volume Structure

Element	Data Type	Required	Length	Allowed Values	Description
Value	Double	M	6	Format: 000.000 Volume > 0 MAX = 100	Shipment Volume.
Unit	String	0	2	Cm3, Inch3	Unit of the volume

3. RESPONSE

3.1 Transaction

Table 10: Transaction Response Description

Element	Description
Reference 1	The Data entered by the customer in the Request process.
Reference 2	The Data entered by the customer in the Request process.
Reference 3	The Data entered by the customer in the Request process.
Reference 4	The Data entered by the customer in the Request process.
Reference 5	The Data entered by the customer in the Request process.

3.2 Has Errors

If there is an error while processing the data entered in a certain field, this element will notify you immediately and further details can be read in the Notification element.

Values Returned

True: An error is identified with your request data; in this case you should fix the request data which is identified for you in the Notification Message. **False:** Error Free, your request was successful.

3.3 List of Notifications

Table 11: Reply - List of Notifications

Element	Description
Code	To Identify the notification category.
Message	Deeper description of the Notification.

3.4 Total amount

Table 12: Reply-Total Amount (Calculated Rate)

Element	Description
Currency Code	If Payment Type is specified then the Currency is as follows: Prepaid = Origin Currency Collect = Destination Currency Third Party = Currency of the Customer Account
Amount	The Monetary Value

4. Rate Calculator conditions:

The result retrieved from the rate calculator will depend on the following conditions:

- If the account details are filled, rate is calculated according to that specified in the customer's account.
- If the account details are not filled, rate is calculated according to the public rate of the origin, given that the payment type is P.
- If the account details are not filled, rate is calculated according to the public rate of the destination, given that the payment type is C.

5. Images of the Back-end User Interface

5.1 A Valid Request with Account Information

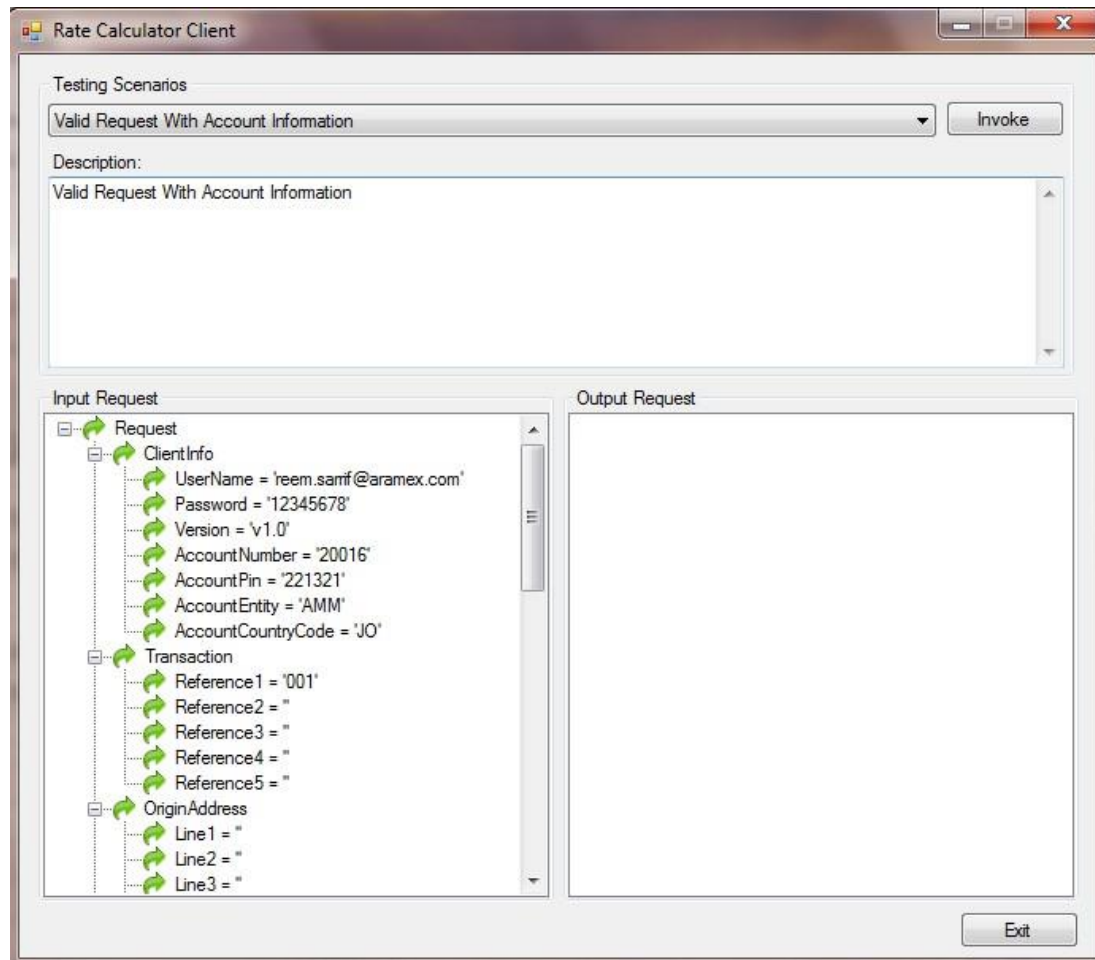

5.2 A Valid Request without Account Information

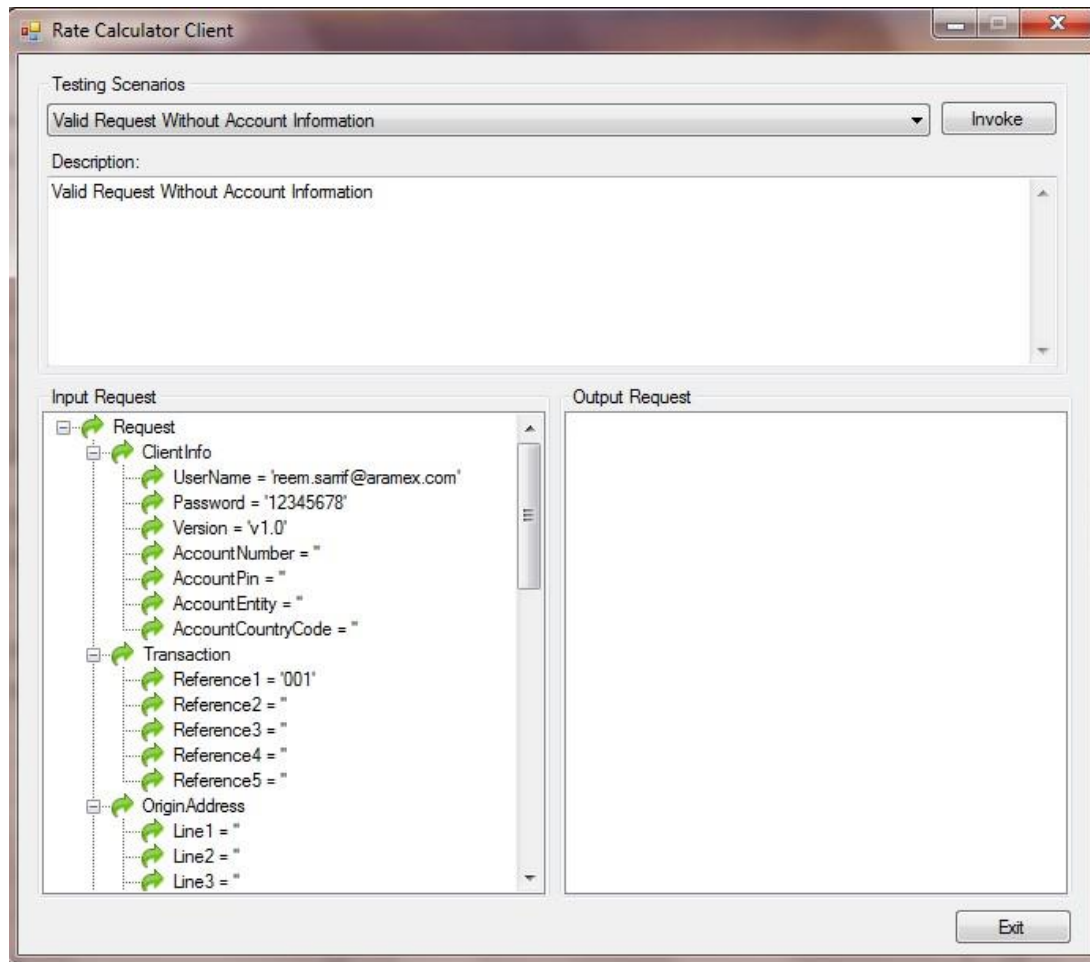

APPENDIX: Aramex and General References

Appendix A - Product Types

Product Type	Name	Dutiable	Full Description	Product Group
PDX	Priority Document Express	No	Urgent, time sensitive consignments containing printed matter or document material	International Express
PPX	Priority Parcel Express	Yes	Urgent, time sensitive consignments containing non-printed matter or non-document material	International Express
PLX	Priority Letter Express	No	Urgent, time sensitive consignments containing printed matter of weight less than 0.5 kg	International Express
DDX	Deferred Document Express	No	2nd Day Delivery consignments containing printed matter or document material	International Express
DPX	Deferred Parcel Express	Yes	2nd Day Delivery consignments containing non-printed matter or non-document material	International Express
GDX	Ground Document Express	No	Ground delivery consignments containing printed matter or document material	International Express
GPX	Ground Parcel Express	Yes	Ground Delivery consignments containing non-printed matter or non-document material	International Express

Appendix B - Shipment Payment Methods

Payment Method	Stands for	Description
----------------	------------	-------------

P	Prepaid	Transportation Charges payable by shipper
C	Collect	Transportation Charges payable by consignee
T	Third Party	Transportation Charges payable by third party. Note: in case of 3rd Party all third party details must be filled including a valid Aramex Account Number for Billing Party.

Appendix C - Service Codes

Service Code	Description	Full Description
COD	Cash on Delivery	Receiver pays the cost of the goods
FIRST	First Delivery	Committed delivery time at destination country.
FRDOM	Free Domicile	Sender pays part/or all of the customs charges and the receiver consignee doesn't pay anything of the shipping or handling charges.
HFPU	Hold for pick up	Receiver picks up the consignment from an Aramex/Partner facility
NOON	Noon Delivery	Committed delivery time BEFORE Noon at destination country.
SIG	Signature Required	Physical receiver signature required upon delivery

Appendix D - ISO Country Codes

Country Code	Country Name	Country Code	Country Name
AF	AFGHANISTAN	LY	LIBYA
AL	ALBANIA	LI	LIECHTENSTEIN
DZ	ALGERIA	LT	LITHUANIA
AS	AMERICAN SAMOA	LU	LUXEMBOURG
AD	ANDORRA	MO	MACAU
AO	ANGOLA	MK	MACEDONIA
AI	ANGUILLA	MG	MADAGASCAR

Your Guide to Embedding Aramex's Rate Calculator

AG	ANTIGUA AND BARBUDA	MW	MALAWI
AR	ARGENTINA	MY	MALAYSIA
AM	ARMENIA	MV	MALDIVES
AW	ARUBA	ML	MALI
AU	AUSTRALIA	MT	MALTA
AT	AUSTRIA	MH	MARSHALL IS
AZ	AZERBAIJAN	MQ	MARTINIQUE
BS	BAHAMAS	MR	MAURITANIA
BH	BAHRAIN	MU	MAURITIUS
BD	BANGLADESH	YT	MAYOTTE
BB	BARBADOS	MX	MEXICO
BY	BELARUS	FM	MICRONESIA
BE	BELGIUM	MD	MOLDOVA
BZ	BELIZE	MC	MONACO
BJ	BENIN	MN	MONGOLIA
BM	BERMUDA	MS	MONTSERRAT
BT	BHUTAN	MA	MOROCCO
BO	BOLIVIA	MZ	MOZAMBIQUE
BA	BOSNIA & HERZEGOVINA	MM	MYANMAR
BW	BOTSWANA	NA	NAMIBIA
IO	BR INDIAN OCEAN TERR	NR	NAURU
BR	BRAZIL	NP	NEPAL
BN	BRUNEI	AN	NETHERLANDS ANTILLES
BG	BULGARIA	NL	NETHERLANDS
BF	BURKINA FASO	NC	NEW CALEDONIA
BI	BURUNDI	NZ	NEW ZEALAND
KH	CAMBODIA	NI	NICARAGUA
CM	CAMEROON	NE	NIGER
CA	CANADA	NG	NIGERIA
RY	CANARY IS	NU	NIUE
CV	CAPE VERDE	NF	NORFOLK ISLAND
KY	CAYMAN IS	MP	NORTHERN MARIANA IS
CF	CENTRAL AFRICAN REP	NO	NORWAY
TD	CHAD	OM	OMAN

Your Guide to Embedding Aramex's Rate Calculator

JE	CHANNEL ISLANDS	PK	PAKISTAN
CL	CHILE	PW	PALAU
CN	CHINA	PS	PALESTINE
CX	CHRISTMAS IS	PA	PANAMA
CC	COCOS KEELING IS	PG	PAPUA NEW GUINEA
CO	COLOMBIA	PY	PARAGUAY
KM	COMOROS	PE	PERU
CG	CONGO	PH	PHILIPPINES
CK	COOK IS	PN	PITCAIRN IS
CR	COSTA RICA	PL	POLAND
HR	CROATIA	PT	PORTUGAL
CU	CUBA	PR	PUERTO RICO
CY	CYPRUS	QA	QATAR
CZ	CZECH REPUBLIC	RE	REUNION IS
CD	DEM REP OF THE CONGO	RO	ROMANIA
DK	DENMARK	RU	RUSSIA
DJ	DJIBOUTI	RW	RWANDA
DM	DOMINICA	WS	SAMOA
DO	DOMINICAN REPUBLIC	SM	SAN MARINO
TP	EAST TIMOR	ST	SAO TOME & PRINCIPE
EC	ECUADOR	SA	SAUDI ARABIA
EG	EGYPT	SN	SENEGAL
SV	EL SALVADOR	YU	SERBIA & MONTENEGRO
GQ	EQUATORIAL GUINEA	SC	SEYCHELLES
ER	ERITREA	SL	SIERRA LEONE
EE	ESTONIA	SG	SINGAPORE
ET	ETHIOPIA	SK	SLOVAKIA
FK	FALKLAND IS	SI	SLOVENIA
FO	FAROE IS	SB	SOLOMON IS
FJ	FIJI	SO	SOMALIA
FI	FINLAND	ZA	SOUTH AFRICA
FR	FRANCE	ES	SPAIN
GF	FRENCH GUIANA	LK	SRI LANKA
PF	FRENCH POLYNESIA	HL	ST HELENA
GA	GABON	KN	ST KITTS & NEVIS

Your Guide to Embedding Aramex's Rate Calculator

GM	GAMBIA	LC	ST LUCIA
GE	GEORGIA	PM	ST PIERRE & MIQUELON
DE	GERMANY	VC	ST VINCENT GRENADINE
GH	GHANA	SD	SUDAN
GI	GIBRALTAR	SR	SURINAM
GR	GREECE	SJ	SVALBARD & JAN MAYEN
GL	GREENLAND	SZ	SWAZILAND
GD	GRENADA	SE	SWEDEN
GP	GUADELOUPE	CH	SWITZERLAND
GU	GUAM	SY	SYRIA
GT	GUATEMALA	TW	TAIWAN
GN	GUINEA	TJ	TAJIKISTAN
GW	GUINEA BISSAU	TZ	TANZANIA
GY	GUYANA	TH	THAILAND
HT	HAITI	TL	Timor-Leste
HM	HEARD & MCDONALD ISLANDS	TG	TOGO
HN	HONDURAS	TK	TOKELAU
HK	HONG KONG	TO	TONGA
HU	HUNGARY	TT	TRINIDAD & TOBAGO
IS	ICELAND	TN	TUNISIA
IN	INDIA	TR	TURKEY
ID	INDONESIA	TM	TURKMENISTAN
IR	IRAN	TC	TURKS & CAICOS IS
IQ	IRAQ	TV	TUVALU
IE	IRELAND	UG	UGANDA
IM	ISLE OF MAN	UA	UKRAINE
IL	ISRAEL	AE	UNITED ARAB EMIRATES
IT	ITALY	GB	UNITED KINGDOM
CI	IVORY COAST	US	UNITED STATES
JM	JAMAICA	UY	URUGUAY
JP	JAPAN	UM	US MINOR OUTLYING IS
JO	JORDAN	UZ	UZBEKISTAN
KZ	KAZAKHSTAN	VU	VANUATU
KE	KENYA	VA	VATICAN CITY
KI	KIRIBATI	VE	VENEZUELA

KP	KOREA NORTH	VN	VIETNAM
KR	KOREA SOUTH	VG	VIRGIN IS - BRITISH
KW	KUWAIT	VI	VIRGIN ISLANDS - US
KG	KYRGYZSTAN	WF	WALLIS & FUTUNA IS
LA	LAOS	EH	WESTERN SAHARA
LV	LATVIA	YE	YEMEN
LB	LEBANON	ZM	ZAMBIA
LS	LESOTHO	ZW	ZIMBABWE
LR	LIBERIA		

Appendix E - Currency Codes

Country Name	Currency Code	Currency Name
AFGHANISTAN	AFA	Afghani
ALGERIA	DZD	Algerian Dinar
NETHERLAND ANTILLES	ANG	Antillean Guilder
ARGENTINA	ARS	Argentine Peso
MADAGASCAR	MGF	Ariary
ARUBA	AWG	Aruban Florin
CHRISTMAS IS	AUD	Australian Dollar
AUSTRALIA	AUD	Australian Dollar
COCOS KEELING IS	AUD	Australian Dollar
KIRIBATI	AUD	Australian Dollar
TUVALU	AUD	Australian Dollar
HEARD & MCDONALD ISLANDS	AUD	Australian Dollar
NORFOLK ISLAND	AUD	Australian Dollar
NAURU	AUD	Australian Dollar
BAHRAIN	BHD	Bahraini Dinar
PANAMA	PAB	Balboa
BARBADOS	BBD	Barbadian Dollar
BELIZE	BZD	Belizean Dollar
BERMUDA	BMD	Bermudian Dollar
ERITREA	ERB	Birr

Your Guide to Embedding Aramex's Rate Calculator

ETHIOPIA	ETB	Birr
VENEZUELA	VEB	Bolivar
BOLIVIA	BOB	Boliviano
BOSNIA & HERZEGOVINA	BAD	Bosnian Dinar
BR INDIAN OCEAN TERR	GBP	British Pound
ISLE OF MAN	GBP	British Pound
CHANNEL ISLANDS__	GBP	British Pound
UNITED KINGDOM	GBP	British Pound
BRUNEI	BND	Bruneian Dollar
BURUNDI	BIF	Burundi Franc
GABON	XAF	C.F.A. Franc
BURKINA FASO	XOF	C.F.A. Franc
BENIN	XOF	C.F.A. Franc
EQUATORIAL GUINEA	XOF	C.F.A. Franc
CONGO	XOF	C.F.A. Franc
IVORY COAST	XOF	C.F.A. Franc
CENTRAL AFRICAN REP	XOF	C.F.A. Franc
CAMEROON	XOF	C.F.A. Franc
NEW CALEDONIA	XPF	C.F.A. Franc
NIGER	XOF	C.F.A. Franc
SENEGAL	XOF	C.F.A. Franc

MALI	MLF	C.F.A. Franc
TOGO	XOF	C.F.A. Franc
FRENCH POLYNESIA	XPF	C.F.A. Franc
WALLIS & FUTUNA IS	XPF	C.F.A. Franc
CHAD	XOF	C.F.A. Franc
CANADA	CAD	Canadian Dollar
CAPE VERDE	CVE	Cape Verdean Escudo
CANARY IS	CVE	Cape Verdean Escudo
CAYMAN IS	CID	Caymanian Dollar
GHANA	GHC	Cedi
CHILE	CLP	Chilean Peso
COLOMBIA	COP	Colombian Peso
COMOROS	KMF	Comoran Franc
COSTA RICA	CRC	Costa Rican Colon

Your Guide to Embedding Aramex's Rate Calculator

BRAZIL	BRE	Cruzeiro
CUBA	CUP	Cuban Peso
CYPRUS	CYP	Cypriot Pound
GAMBIA	GMD	Dalasi
GREENLAND	DKK	Danish Krone
DENMARK	DKK	Danish Krone
FAROE IS	DKK	Danish Krone
MACEDONIA	MKD	Denar
UNITED ARAB EMIRATES	AED	Dirham
DJIBOUTI	DJF	Djibouti Franc
SAO TOME & PRINCIPE	STD	Dobra
DOMINICAN REPUBLIC	DOP	Dominican Peso
ARMENIA	AMD	Dram
DOMINICA	XCD	East Caribbean Dollar
ANTIGUA AND BARBUDA	XCD	East Caribbean Dollar
ANGUILLA	XCD	East Caribbean Dollar
GRENADA	XCD	East Caribbean Dollar
ST LUCIA	XCD	East Caribbean Dollar
ST KITTS & NEVIS	XCD	East Caribbean Dollar
MONTSERRAT	XCD	East Caribbean Dollar
ST VINCENT&GRENADINE	XCD	East Caribbean Dollar
EGYPT	EGP	Egyptian Pound
GERMANY	EUR	Euro
AUSTRIA	EUR	Euro
SPAIN	EUR	Euro
BELGIUM	EUR	Euro
IRELAND	EUR	Euro
LUXEMBOURG	EUR	Euro
MONACO	EUR	Euro
ITALY	EUR	Euro
FINLAND	EUR	Euro

FRANCE	EUR	Euro
GREECE	EUR	Euro
MAYOTTE	EUR	Euro
NETHERLANDS	EUR	Euro

Your Guide to Embedding Aramex's Rate Calculator

PORTUGAL	EUR	Euro
FALKLAND IS	FKP	Falkland Pound
FIJI	FJD	Fijian Dollar
HUNGARY	HUF	Forint
FRENCH GUIANA	FRF	French Franc
GUADELOUPE	FRF	French Franc
REUNION IS	FRF	French Franc
MARTINIQUE	FRF	French Franc
ST PIERRE & MIQUELON	FRF	French Franc
GIBRALTAR	GIP	Gibraltar Pound
NICARAGUA	NIC	Gold Cordoba
HAITI	HTG	Gourde
PARAGUAY	PYG	Guarani
GUINEA BISSAU	GWP	Guinea-Bissauan Peso
GUYANA	GYD	Guyanese Dollar
HONG KONG	HKD	Hong Kong Dollar
UKRAINE	UAH	Hryvnia
INDIA	INR	Indian Rupee
INDONESIA	IDR	Indonesian Rupiah
IRAN	IRR	Iranian Rial
IRAQ	IQD	Iraqi Dinar
SAN MARINO	ITL	Italian Lira
VATICAN CITY	ITL	Italian Lira
JAMAICA	JMD	Jamaican Dollar
JORDAN	JOD	Jordanian Dinar
KENYA	KES	Kenyan Shilling
PAPUA NEW GUINEA	PGK	Kina
CZECH REPUBLIC	CZK	Koruna
SLOVAKIA	SKK	Koruna
ICELAND	ISK	Krona
ESTONIA	EEK	Kroon
CROATIA	HRK	Kuna
KUWAIT	KWD	Kuwaiti Dinar
ANGOLA	AOK	Kwanza
MYANMAR	MMK	Kyat
GEORGIA	GEK	Lari

Your Guide to Embedding Aramex's Rate Calculator

LATVIA	LVL	Lat
LEBANON	LBP	Lebanese Pound
ALBANIA	ALL	Lek
HONDURAS	HNL	Lempira
SIERRA LEONE	SLL	Leone

ROMANIA	ROL	Leu
MOLDOVA	MDL	Leu
BULGARIA	BGL	Lev
LIBERIA	LRD	Liberian Dollar
LIBYA	LYD	Libyan Dinar
SWAZILAND	SZL	Lilangeni
LITHUANIA	LTL	Litas
LESOTHO	LSL	Loti
MALAWI	MWK	Malawian Kwacha
MALTA	MTL	Maltese Lira
TURKMENISTAN	TMM	Manat
MAURITIUS	MUR	Mauritian Rupee
MOZAMBIQUE	MZM	Metical
WESTERN SAHARA	MAD	Moroccan Dirham
MOROCCO	MAD	Moroccan Dirham
NIGERIA	NGN	Naira
NAMIBIA	NAD	Namibian Dollar
NEPAL	NPR	Nepalese Rupee
SERBIA & MONTENEGRO	YUN	New Dinar
VIETNAM	VND	New Dong
ISRAEL	ILS	New Israeli Shekel
PALESTINE	ILS	New Israeli Shekel
LAOS	LAK	New Kip
TAIWAN	TWD	New Taiwan Dollar
URUGUAY	UYP	New Uruguayan Peso
DEM REP OF THE CONGO	ZRN	New Zaire
PITCAIRN IS	NZD	New Zealand Dollar
COOK IS	NZD	New Zealand Dollar
TOKELAU	NZD	New Zealand Dollar
NEW ZEALAND	NZD	New Zealand Dollar

Your Guide to Embedding Aramex's Rate Calculator

NIUE	NZD	New Zealand Dollar
POLAND	PLZ	New Zloty
BHUTAN	BTN	Ngultrum
YEMEN	YER	North Yemeni Riyal
SVALBARD & JAN MAYEN	NOK	Norwegian Krone
NORWAY	NOK	Norwegian Krone
MEXICO	MXN	Nuevo Peso
PERU	PEN	Nuevo Sol
OMAN	OMR	Omani Rial
MAURITANIA	MRO	Ouguiya
TONGA	TOP	Pa'anga
PAKISTAN	PKR	Pakistani Rupee
MACAU	MOP	Pataca
PHILIPPINES	PHP	Philippine Peso
ST HELENA	SHP	Pound

BOTSWANA	BWP	Pula
QATAR	QAR	Qatari Riyal
GUATEMALA	GTQ	Quetzal
SOUTH AFRICA	ZAR	Rand
CAMBODIA	KHR	Riel
MALAYSIA	MYR	Ringgit
BELARUS	RUR	Ruble
RUSSIA	RUR	Ruble
TAJIKISTAN	RUR	Ruble
MALDIVES	MVR	Rufiyaa
RWANDA	RWF	Rwandan Franc
EL SALVADOR	SVC	Salvadoran Colon
SAUDI ARABIA	SAR	Saudi Riyal
SEYCHELLES	SCR	Seychelles Rupee
SINGAPORE	SGD	Singapore Dollar
SOLOMON IS	SBD	Solomon Islands Dollar
KYRGYZSTAN	KGS	Som
UZBEKISTAN	KGS	Som
SOMALIA	SOS	Somali Shilling
ANDORRA	SPP	Spanish Peseta

Your Guide to Embedding Aramex's Rate Calculator

SRI LANKA	LKR	Sri Lankan Rupee
ECUADOR	ECS	Sucre
SUDAN	SDD	Sudanese Dinar
SURINAM	SRG	Surinamese Guilder
SWEDEN	SEK	Swedish Krona
SWITZERLAND	CHF	Swiss Franc
LIECHTENSTEIN	CHF	Swiss Franc
GUINEA	GNS	Syli
SYRIA	SYP	Syrian Pound
SAMOA	SAT	Tala
TANZANIA	TZS	Tanzanian Shilling
KAZAKHSTAN	KZT	Tenge
SLOVENIA	SIT	Tolar
TRINIDAD & TOBAGO	TTD	Trinidad & Tobago Dollar
MONGOLIA	MNT	Tughrik
TUNISIA	TND	Tunisian Dinar
TURKEY	YTL	Turkish Lira
UGANDA	UGX	Ugandan Shilling
AMERICAN SAMOA	USD	United States Dollar
AZERBAIJAN	USD	United States Dollar
BANGLADESH	USD	United States Dollar
BAHAMAS	USD	United States Dollar
GUAM	USD	United States Dollar
US MINOR OUTLYING IS	USD	United States Dollar
MICRONESIA	USD	United States Dollar
UNITED STATES	USD	United States Dollar
Timor-Leste	USD	United States Dollar
PALAU	USD	United States Dollar
MARSHALL IS	USD	United States Dollar
NORTHERN MARIANA IS	USD	United States Dollar
THAILAND	USD	United States Dollar
EAST TIMOR	USD	United States Dollar
VIRGIN IS - BRITISH	USD	United States Dollar
VIRGIN ISLANDS - US	USD	United States Dollar
PUERTO RICO	USD	United States Dollar
TURKS & CAICOS IS	USD	United States Dollar

Your Guide to Embedding Aramex's Rate Calculator

VANUATU	VUV	Vatu
KOREA NORTH	KPW	Won
KOREA SOUTH	KRW	Won
JAPAN	JPY	Yen
CHINA	CNY	Yuan
ZAMBIA	ZMK	Zambian Kwacha
ZIMBABWE	ZWD	Zimbabwean Dollar

Appendix F - Error Codes and Messages

Error Code	Error Message
Missing Parameter Error	ClientInfo is empty
Missing Parameter Error	OriginAddress is empty
Missing Parameter Error	DestinationAddress is empty
Missing Parameter Error	ShipmentDetails is empty
ClientInfo - UserName Missing Value Error	UserName is empty
ClientInfo - Password Missing Value Error	Password is empty
ClientInfo - Version Missing Value Error	Version is empty
ClientInfo - AccountNumber Missing Value Error	AccountNumber is empty
ClientInfo - AccountPin Missing Value Error	AccountPin is empty
ClientInfo - AccountEntity Missing Value Error	AccountEntity is empty
ClientInfo - AccountCountryCode Missing Value Error	AccountCountryCode is empty
ClientInfo - Login Error	Invalid username or password
ClientInfo - Account Error	Invalid account information
ClientInfo - Account Error	Account is blocked
OriginAddress - City Missing Value Error	City is empty
OriginAddress - CountryCode Missing Value Error	CountryCode is empty
DestinationAddress - City Missing Value Error	City is empty
DestinationAddress - CountryCode Missing Value Error	CountryCode is empty
ShipmentDetails - NumberOfPieces Missing Value Error	NumberOfPieces is less or equal zero
ShipmentDetails - ActualWeight Missing Value Error	ActualWeight is empty
ActualWeight - Value Missing Value Error	Value is less or equal zero
ActualWeight - Unit Missing Value Error	Unit is empty
ActualWeight - Unit Invalid Value Error	Unit is invalid
ChargeableWeight - Unit Missing Value Error	Unit is empty
ChargeableWeight - Unit Invalid Value Error	Unit is invalid

Your Guide to Embedding Aramex's Rate Calculator

ShipmentDetails - ProductGroup Missing Value Error	ProductGroup is empty
ShipmentDetails - ProductGroup Invalid Value Error	ProductGroup is invalid
ShipmentDetails - ProductType Missing Value Error	ProductType is empty
ShipmentDetails - ProductType Invalid Value Error	ProductType is invalid
ShipmentDetails - PaymentType Missing Value Error	PaymentType is empty
ShipmentDetails - PaymentType Invalid Value Error	PaymentType is invalid
CashOnDeliveryAmount - Value Missing Value Error	Value is less than zero
CashOnDeliveryAmount - CurrencyCode Missing Value Error	CurrencyCode is empty
CashOnDeliveryAmount - CurrencyCode Invalid Value Error	CurrencyCode is invalid
CollectAmount - Value Missing Value Error	Value is less than zero
CollectAmount - CurrencyCode Missing Value Error	CurrencyCode is empty
CollectAmount - CurrencyCode Invalid Value Error	CurrencyCode is invalid
InsuranceAmount - Value Missing Value Error	Value is less than zero
InsuranceAmount - CurrencyCode Missing Value Error	CurrencyCode is empty
InsuranceAmount - CurrencyCode Invalid Value Error	CurrencyCode is invalid
CustomsValueAmount - Value Missing Value Error	Value is less than zero
CustomsValueAmount - CurrencyCode Missing Value Error	CurrencyCode is empty
CustomsValueAmount - CurrencyCode Invalid Value Error	CurrencyCode is invalid
Origin Address Error	Any error messages returned by the address resolver service
Destination Address Error	Any error messages returned by the address resolver service

Your Guide to Embedding Aramex's Rate Calculator

